



AF1117A Series

1A Bipolar Linear Regulator

➤ Description

The AF1117A is a series of low dropout voltage, three-terminal regulators. Its application circuit is very simple: the fixed version only needs two capacitors and the adjustable version only needs two resistors and two capacitors to work. Other than a fixed version, $V_{OUT}=1.2V, 1.5V, 1.8V, 2.5V, 3.3V, 5V$ and $12V$, AF1117A has an adjustable version, which can provide an output voltage from $1.25V$ to $5.0V$ with only two external resistors. The output voltage of adjustable version follows the equation: $V_{OUT}=1.25 \times (1+R2/R1) + I_{Adj} \times R2$. We can ignore I_{Adj} because I_{Adj} (about $50\mu A$) is much less than the current of $R1$ (about $2\sim 10mA$). To meet the minimum load current ($>10mA$) requirement, $R1$ is recommended to be 125Ω or lower. As AF1117A-ADJ can keep itself stable at load current about $2mA$, $R1$ is not allowed to be higher than 625Ω .

AF1117A offers thermal shut down and current limit functions, to assure the stability of chip and power system. And it uses trimming technique to guarantee output voltage accuracy within 2%. Other output voltage accuracy can be customized on demand, such as 1%. AF1117A is available in SOT-223 and SOT-89-3L power package. The moisture sensitivity level is currently up to MSL3.

➤ Applications

- Power management for Computer Mother Board, Graphic Card
- LCD Monitor and LCD TV
- DVD Decode Board
- ADSL Modem
- Post Regulators for Switching Supplies

➤ Ordering Information

Package	Packing	Shipping
SOT-223	Tape and Reel	2.5K/Reel
SOT-89-3L		1K/Reel

➤ Features

- Maximum output current is 1A
- Input Voltage Range: $2.5V\sim 18V$
- Line regulation: $0.1\%/V$ (typ.)
- Standby current: $2mA$ (typ.)
- Load regulation: $10mV$ (typ.)
- Environment Temperature: $-40\sim 85(^{\circ}C)$

➤ Typical Application

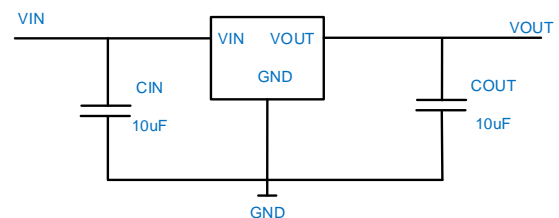

Fixed Output

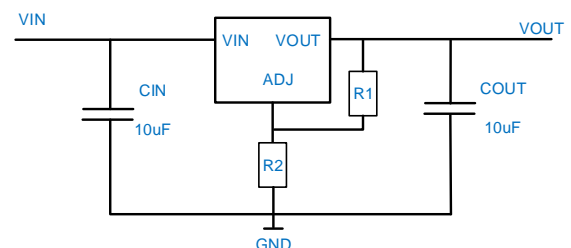

ADJ Output

➤ Device Information

AF 1117A – XX L/P

① ② ③ ④

①	Standard
②	Product Name
③	Output Voltage e.g. 33 = 3.3V
④	L: SOT-223 Package
	P: SOT-89-3L Package

➤ PIN Configuration

SYMBOL	Package Pin	
	SOT-223	SOT-89-3L
1	GND/Adj	GND/Adj
2	V _{OUT}	V _{OUT}
3	V _{IN}	V _{IN}

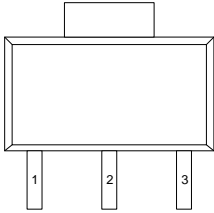

SOT-223 (Top View)

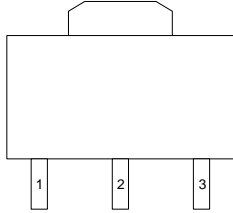

SOT-89-3L (Top View)

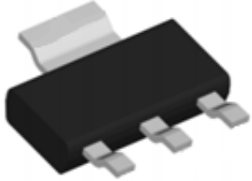

SOT-223 (Bottom View)



SOT-89-3L (Bottom View)

➤ Marking Information

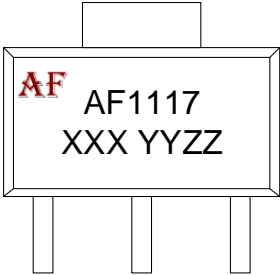
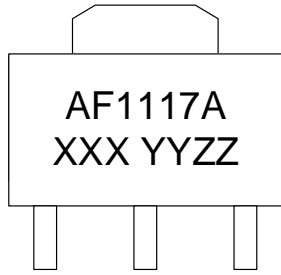
 <p>SOT-223 (Top View)</p>		 <p>SOT-89-3L (Top View)</p>	
AF1117	Product Code	AF1117A	Product Code
XXX	Output Voltage	XXX	Output Voltage
	3V3: 3.3V		3V3: 3.3V
	ADJ: adjustable		ADJ: adjustable
YY	Year	YYZZ	Internal Traceability Code
ZZ	Week		

➤ Block Diagram

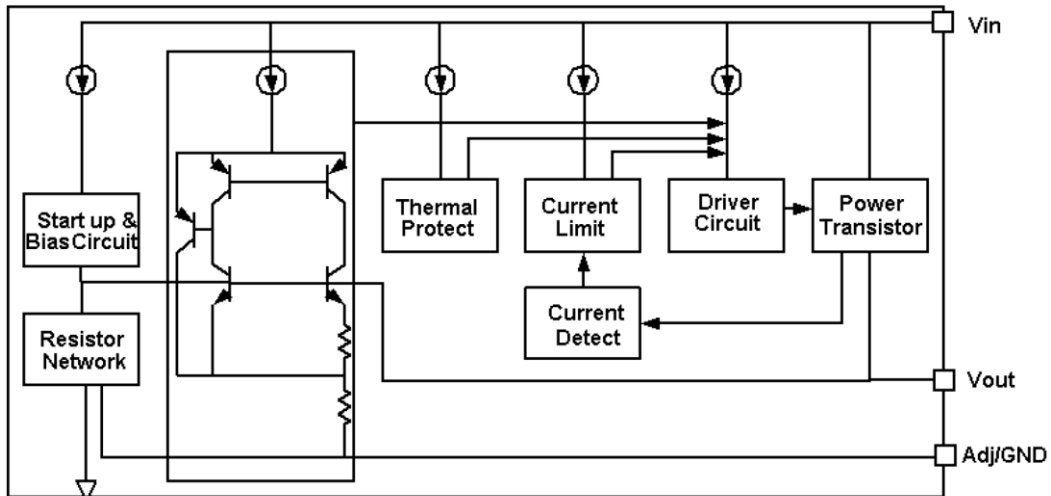

➤ Thermal Information

Package Thermal Resistance	Rating	Unit
SOT-223	20	°C/W
SOT-89-3L	30	

➤ Absolute Maximum Ratings^① (Unless otherwise specified, T_A=25°C, all voltage are with respect to GND)

Parameter	Value
Max Input Voltage	18V
Max Power Dissipation	1.2W
Max Output Current	1A
Max Operating Junction Temperature	150°C
Ambient Temperature	-40°C~85°C
Storage Temperature	-40°C~150°C
Lead Temperature & Time	260°C, 10s

①. Stresses beyond those listed under absolute maximum ratings may cause permanent damage to the device. These are stress ratings only, and functional operation of the device at these or any other conditions beyond those indicated under recommended operating conditions is not implied. Exposure to absolute-maximum-rated conditions for extended periods may affect device reliability.



➤ **Electronics Characteristics (Unless otherwise specified, $T_A=25^\circ\text{C}$)**

Symbol	Parameter	Conditions	Min.	Typ.	Max.	Unit
V_{ref}	Reference Voltage	AF1117A-ADJ $10\text{mA} \leq I_{out} \leq 1\text{A}$, $V_{in}=3.25\text{V}$	1.225	1.25	1.275	V
V_{out}	Output Voltage	AF1117A-1.2V $0 \leq I_{out} \leq 1\text{A}$, $V_{in}=3.2\text{V}$	1.176	1.2	1.224	V
		AF1117A-1.5V $0 \leq I_{out} \leq 1\text{A}$, $V_{in}=3.5\text{V}$	1.465	1.5	1.535	
		AF1117A-1.8V $0 \leq I_{out} \leq 1\text{A}$, $V_{in}=3.8\text{V}$	1.76	1.8	1.836	
		AF1117A-2.5V $0 \leq I_{out} \leq 1\text{A}$, $V_{in}=4.5\text{V}$	2.45	2.5	2.55	
		AF1117A-3.3V $0 \leq I_{out} \leq 1\text{A}$, $V_{in}=5.3\text{V}$	3.234	3.3	3.366	
		AF1117A-5.0V $0 \leq I_{out} \leq 1\text{A}$, $V_{in}=7.0\text{V}$	4.9	5	5.1	
		AF1117A-12.0V $0 \leq I_{out} \leq 1\text{A}$, $V_{in}=14\text{V}$	11.76	12	12.24	
ΔV_{OUT}	Line Regulation	AF1117A-ADJ $I_{out}=10\text{mA}$ $2.75\text{V} \leq V_{in} \leq 12\text{V}$		0.1	0.4	%V
		AF1117A-1.2V $I_{out}=10\text{mA}$ $2.7\text{V} \leq V_{in} \leq 10\text{V}$		0.1	0.4	
		AF1117A-1.5V $I_{out}=10\text{mA}$ $3.0\text{V} \leq V_{in} \leq 11\text{V}$		0.1	0.4	
		AF1117A-1.8V $I_{out}=10\text{mA}$ $3.3\text{V} \leq V_{in} \leq 12\text{V}$		0.1	0.4	
		AF1117A-2.5V $I_{out}=10\text{mA}$ $4.0\text{V} \leq V_{in} \leq 12\text{V}$		0.1	0.4	
		AF1117A-3.3V $I_{out}=10\text{mA}$ $4.8\text{V} \leq V_{in} \leq 12\text{V}$		0.1	0.4	
		AF1117A-5.0V $I_{out}=10\text{mA}$ $6.5\text{V} \leq V_{in} \leq 12\text{V}$		0.1	0.4	
V_{drop}	Dropout Voltage	$I_{out}=100\text{mA}$		1.23	1.3	V
		$I_{out}=1\text{A}$		1.3	1.5	V
ΔV_{OUT}	Load Regulation	AF1117A-ADJ $V_{in}=2.75\text{V}$, $10\text{mA} \leq I_{out} \leq 1\text{A}$		10	32	mV
		AF1117A-1.2V $V_{in}=2.7\text{V}$, $10\text{mA} \leq I_{out} \leq 1\text{A}$		10	32	
		AF1117A-1.5V $V_{in}=3.0\text{V}$, $10\text{mA} \leq I_{out} \leq 1\text{A}$		10	32	
		AF1117A-1.8V		10	32	



AF1117A

		Vin=3.3V, 10mA ≤ Iout ≤ 1A				
		AF1117A-2.5V Vin=4.0V, 10mA ≤ Iout ≤ 1A		10	32	
		AF1117A-3.3V Vin=4.8V, 10mA ≤ Iout ≤ 1A		10	32	
		AF1117A-5.0V Vin=6.5V, 10mA ≤ Iout ≤ 1A		10	32	
		AF1117A-12.0V Vin=13.5V, 10mA ≤ Iout ≤ 1A		10	32	
I _Q	Quiescent Current	AF1117A-ADJ, Vin=12V		2	5	mA
		AF1117A-1.2V, Vin=10V		2	5	
		AF1117A-1.5V, Vin=11V		2	5	
		AF1117A-1.8V, Vin=12V		2	5	
		AF1117A-2.5V, Vin=12V		2	5	
		AF1117A-3.3V, Vin=12V		2	5	
		AF1117A-5.0V, Vin=12V		2	5	
		AF1117A-12.0V, Vin=20V		2	5	
P _{SR}	Power Supply Rejection Ratio	f=100Hz, Cout=104		-65		dB
		f=1KHz, Cout=104		-65		
		f=10KHz, Cout=104		-60		
		f=22KHz, Cout=104		-70		
I _{Adj}	Adjust Pin Current	AF1117A-ADJ Vin=5V, 10mA ≤ Iout ≤ 1A		55	120	uA
I _{change}	Change Current	AF1117A-ADJ Vin=5V, 10mA ≤ Iout ≤ 1A		0.2	10	uA
I _{lim}	Output Limit Current	Vin-Vout=2V	0.8			A
I _{min}	Minimum Load Current	AF1117A-ADJ	2	10		mA
ΔV/ΔT	Temperature Coefficient	Iout = 40mA		±100		ppm/°C



➤ Typical Characteristics (Unless otherwise specified, $T_A=25^\circ\text{C}$)

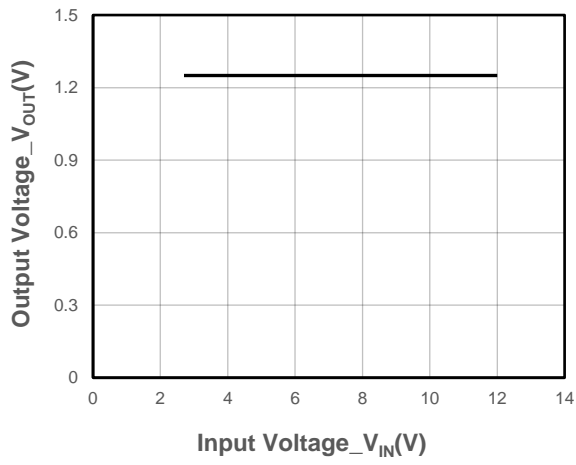

Output Voltage vs. Input Voltage

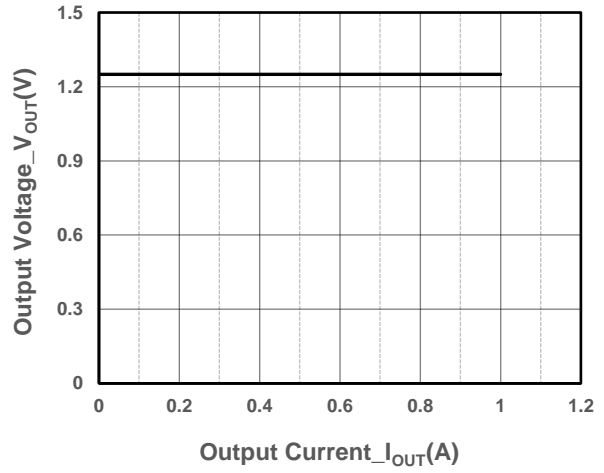

Output Voltage vs. Output Current

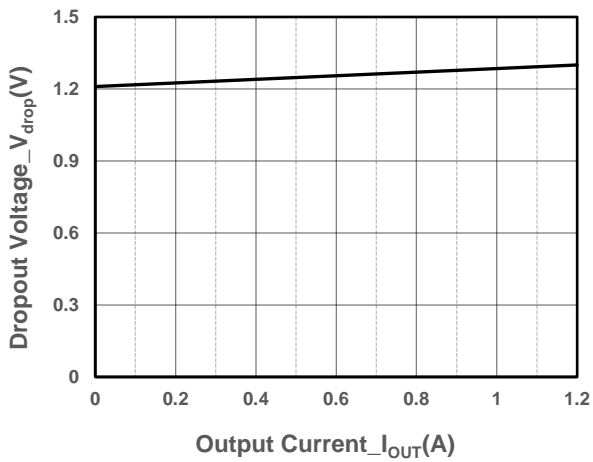

Dropout Voltage vs. Output Current

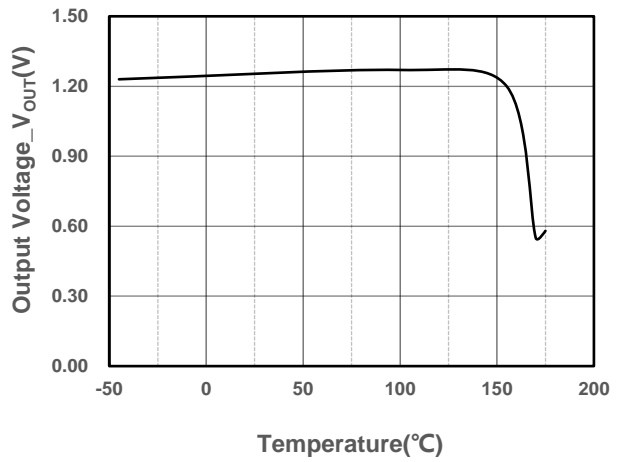

Output Voltage vs. Temperature

➤ Package Information

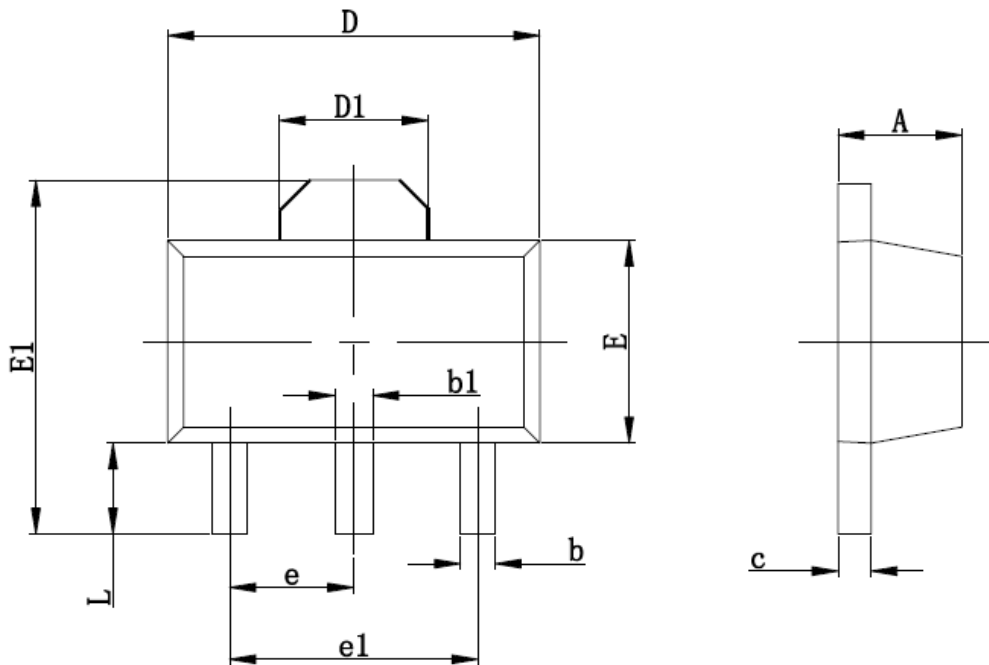
SOT-89-3L

Symbol	Dimensions In Millimeters		Dimensions In Inches	
	Min	Max	Min	Max
A	1.400	1.600	0.055	0.063
b	0.350	0.520	0.013	0.197
b1	0.400	0.580	0.016	0.023
c	0.350	0.440	0.014	0.017
D	4.400	4.600	0.173	0.181
D1	1.550 REF		0.061 REF	
E	2.350	2.550	0.091	0.102
E1	3.940	4.250	0.155	0.167
e	1.500 TYP		0.060TYP	
e1	3.000 TYP		0.118TYP	
L	0.900	1.100	0.035	0.047

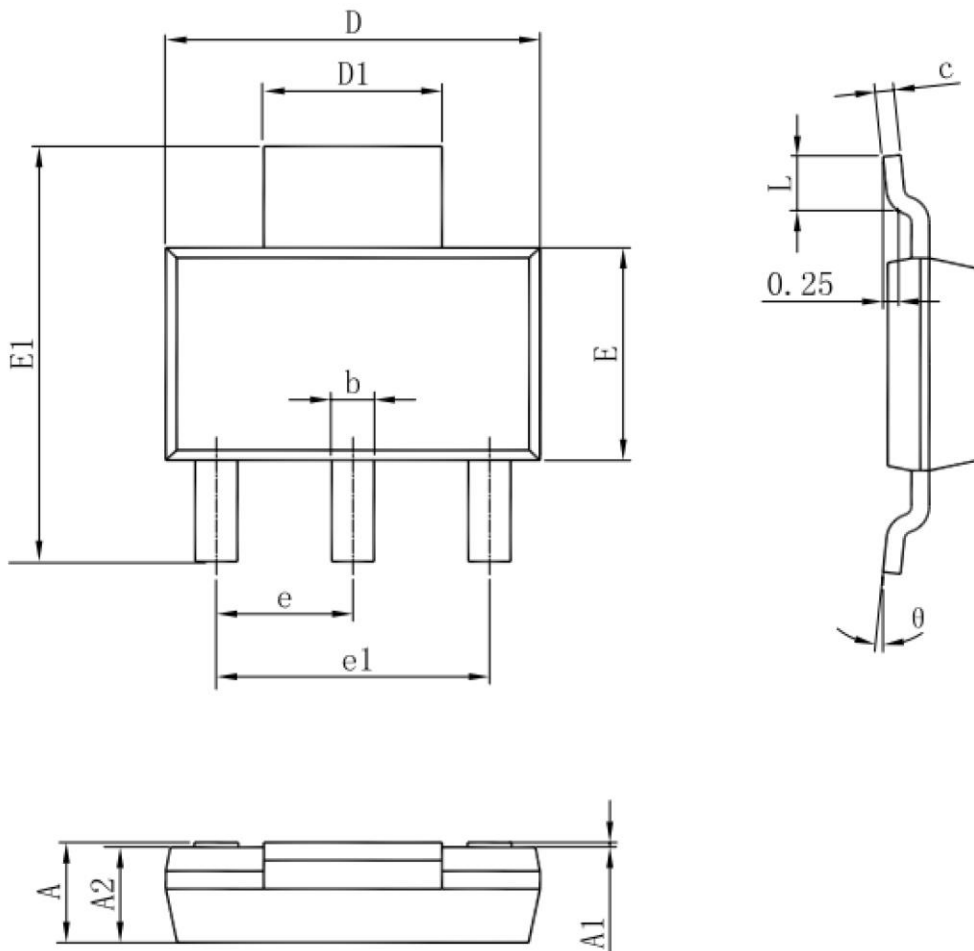
SOT-223

Symbol	Dimensions In Millimeters		Dimensions In Inches	
	Min	Max	Min	Max
A	1.520	1.800	0.060	0.071
A1	0.000	0.100	0.000	0.004
A2	1.500	1.700	0.059	0.067
b	0.660	0.820	0.026	0.032
c	0.250	0.350	0.010	0.014
D	6.200	6.400	0.244	0.252
D1	2.900	3.100	0.114	0.122
E	3.300	3.700	0.130	0.146
E1	6.830	7.070	0.269	0.278
e	2.300(BSC)		0.091(BSC)	
e1	4.500	4.700	0.177	0.185
L	0.900	1.150	0.035	0.045
θ	0°	10°	0°	10°



DISCLAIMER

SSCSEMI RESERVES THE RIGHT TO MAKE CHANGES WITHOUT FURTHER NOTICE TO ANY PRODUCTS HEREIN TO IMPROVE RELIABILITY, FUNCTION OR DESIGN. SSCSEMI DOES NOT ASSUME ANY LIABILITY ARISING OUT OF THE APPLICATION OR USE OF ANY PRODUCT OR CIRCUIT DESCRIBED HEREIN; NEITHER DOES IT CONVEY ANY LICIENCE UNDER ITS PATENT RIGHTS, NOR THE RIGHTS OF OTHERS.

THE GRAPHS PROVIDED IN THIS DOCUMENT ARE STATISTICAL SUMMARIES BASED ON A LIMITED NUMBER OF SAMPLES AND ARE PROVIDED FOR INFORMATIONAL PURPOSE ONLY. THE PERFORMANCE CHARACTERISTICS LISTED IN THEM ARE NOT TESTED OR GUARANTEED. IN SOME GRAPHS, THE DATA PRESENTED MAY BE OUTSIDE THE SPECIFIED OPERATING RANGE (E.G. OUTSIDE SPECIFIED POWER SUPPLY RANGE) AND THEREFORE OUTSIDE THE WARRANTED RANGE.

OUR PRODUCT SPECIFICATIONS ARE ONLY VALID IF OBTAINED THROUGH THE COMPANY'S OFFICIAL WEBSITE, CRM SYSTEM, OR OUR SALES PERSONNEL CHANNELS. IF CHANGES OR SPECIAL VERSIONS ARE INVOLVED, THEY MUST BE STAMPED WITH A QUALITY SEAL AND MARKED WITH A SPECIAL VERSION NUMBER TO BE VALID.