



SSC8633GSB

N- and P-Channel Complementary, MOSFET

➤ Features

N-Channel

VDS	VGS	RDSON Typ.	ID
30V	±16V	42mR@10V	3.6A
		46mR@4V5	
		56mR@2V5	

P-Channel

VDS	VGS	RDSON Typ.	ID
-30V	±12V	48mR@-10V	-3.2A
		55mR@-4V5	
		77mR@-2V5	

➤ Description

SSC8633GSB uses advanced trench technology to provide excellent RDSON and low gate charge. The complementary MOSFETS may be used to form a level shifted high side switch, and for a host of other applications.

➤ Applications

- Inverter
- CCFL Driver
- Half and Full Bridge Topology

➤ Pin configuration

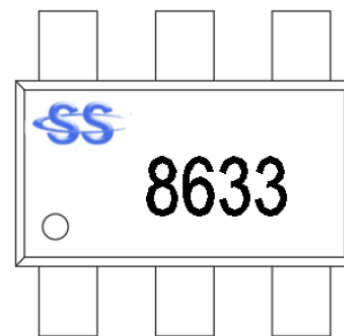
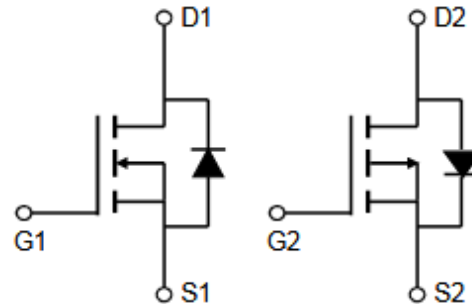
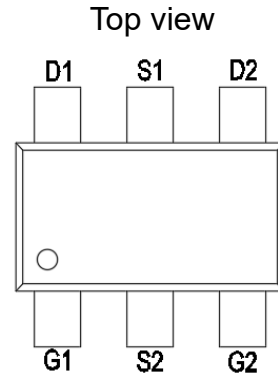

Marking

➤ Ordering Information

Device	Package	Shipping
SSC8633GSB	SOT23-6L	3000/Reel



➤ **Absolute Maximum Ratings**($T_A=25^{\circ}\text{C}$ unless otherwise noted)

Symbol	Parameter		N-Channel	P-Channel	Unit
V_{DSS}	Drain-to-Source Voltage		30	-30	V
V_{GSS}	Gate-to-Source Voltage		± 12	± 12	V
I_D	Continuous Drain Current ^a	$T_A=25^{\circ}\text{C}$	3.6	-3.2	A
		$T_A=70^{\circ}\text{C}$	2.2	-2	A
I_{DM}	Pulsed Drain Current ^b		14	-12	A
P_{DSM}	Power Dissipation ^a		2.4		W
P_D	Power Dissipation ^c	$T_A=25^{\circ}\text{C}$	1.2		W
		$T_A=70^{\circ}\text{C}$	0.75		W
T_J	Operation junction temperature		-55 to 150		$^{\circ}\text{C}$
T_{STG}	Storage temperature range		-55 to 150		$^{\circ}\text{C}$

➤ **Thermal Resistance Ratings**($T_A=25^{\circ}\text{C}$ unless otherwise noted)

Symbol	Parameter	Typical	Maximum	Unit
$R_{\theta JA}$	Junction-to-Ambient Thermal Resistance ^a		105	$^{\circ}\text{C}/\text{W}$
$R_{\theta JC}$	Junction-to-Case Thermal Resistance		52	

Note:

- The value of $R_{\theta JA}$ is measured with the device mounted on 1 in² FR-4 board with 2oz.copper,in a still air environment with $T_A=25^{\circ}\text{C}$.The value in any given application depends on the user is specific board design. The current rating is based on the $t \leq 10\text{s}$ thermal resistance rating.
- Repetitive rating, pulse width limited by junction temperature.
- The power dissipation P_D is based on $T_{J(MAX)}=150^{\circ}\text{C}$, using junction-to-case thermal resistance, and is more useful in setting the upper dissipation limit for cases where additional heat sinking is used.



➤ **Electronics Characteristics**($T_A=25^{\circ}\text{C}$ unless otherwise noted)

Symbol	Parameter	Test Conditions		Min	Typ.	Max	Unit
$V_{(BR)DSS}$	Drain-Source Breakdown Voltage	$V_{GS}=0V, I_D=250\mu A$	N-CH	30			V
		$V_{GS}=0V, I_D=-250\mu A$	P-CH	-30			
$V_{GS(th)}$	Gate Threshold Voltage	$V_{DS}=V_{GS}, I_D=250\mu A$	N-CH	0.7	1	1.3	V
		$V_{DS}=V_{GS}, I_D=-250\mu A$	P-CH	-0.6	-0.9	-1.3	
$R_{DS(on)}$	Drain-Source On-Resistance	$V_{GS}=10V, I_D=3.6A$	N-CH		42	55	mR
		$V_{GS}=10V, I_D=-3.2A$	P-CH		48	65	
		$V_{GS}=4.5V, I_D=3A$	N-CH		46	70	
		$V_{GS}=-4.5V, I_D=-2A$	P-CH		55	75	
		$V_{GS}=2.5V, I_D=2A$	N-CH		56	80	
		$V_{GS}=-2.5V, I_D=-1.8A$	P-CH		77	100	
I_{DSS}	Zero Gate Voltage Drain Current	$V_{DS}=24V, V_{GS}=0V$	N-CH			1	uA
		$V_{DS}=-24V, V_{GS}=0V$	P-CH			-1	
I_{GSS}	Gate-Source leak current	$V_{GS}=\pm 16V, V_{DS}=0V$	N-CH			± 100	nA
		$V_{GS}=\pm 12V, V_{DS}=0V$	P-CH			± 100	
G_{FS}	Forward Transconductance	$V_{DS}=5V, I_D=2A$	N-CH		10		S
		$V_{DS}=-5V, I_D=-2A$	P-CH		15		
V_{SD}	Forward Voltage	$V_{GS}=0V, I_S=1A$	N-CH		0.78	1.3	V
		$V_{GS}=0V, I_S=-1A$	P-CH		-0.77	-1.3	
C_{iss}	Input Capacitance	NMOS: $V_{DS}=15V,$ $V_{GS}=0V, f=1\text{MHZ}$ PMOS: $V_{DS}=-15V,$ $V_{GS}=0V, f=1\text{MHZ}$	N-CH		510		pF
	P-CH			430			
C_{oss}	Output Capacitance		N-CH		70		
			P-CH		60		
C_{rss}	Reverse Transfer Capacitance		N-CH		45		
			P-CH		40		



Qg	Total Gate Charge	NMOS: VDS=15V, VGS=4.5V, ID=4A PMOS: VDS=-15V, VGS=- 4.5V, ID=-3A	N-CH	10	nC
			P-CH	9	
Qgs	Gate Source Charge		N-CH	2.2	
			P-CH	2.3	
Qgd	Gate Drain Charge		N-CH	1.1	
			P-CH	1.9	
T _{D(ON)}	Turn-on delay time	NMOS: VDS=15V, VGS=10V, RL=10R, RGEN=6R PMOS: VDS=-15V, VGS=-10V, RL=10R, RGEN=6R	N-CH	9	ns
			P-CH	13	
Tr	Rise time		N-CH	12	
			P-CH	15	
T _{D(OFF)}	Turn-off delay time		N-CH	26	
			P-CH	21	
Tf	Fall time		N-CH	18	
			P-CH	14	



➤ **N-Channel Typical Characteristics**($T_A=25^\circ\text{C}$ unless otherwise noted)

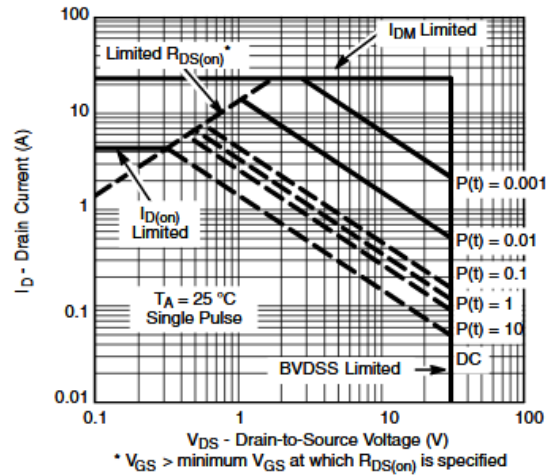
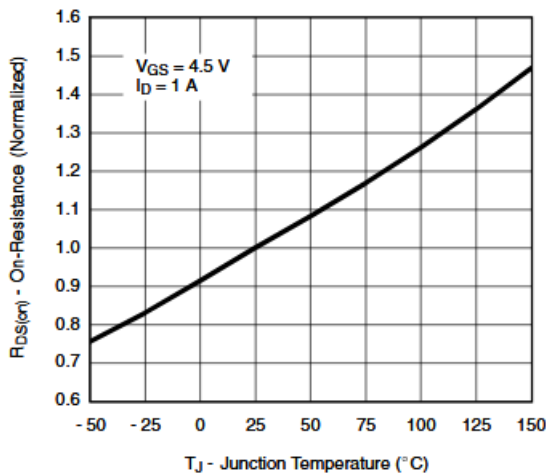
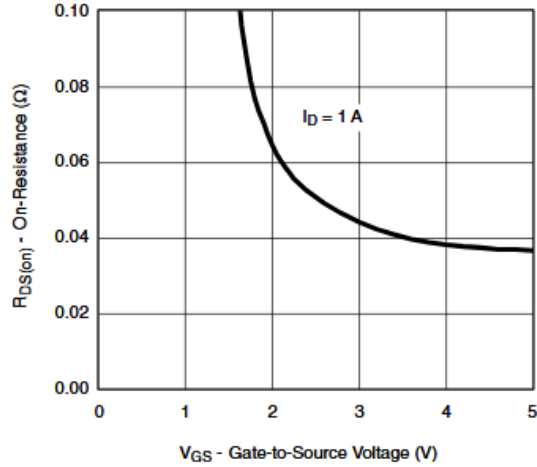
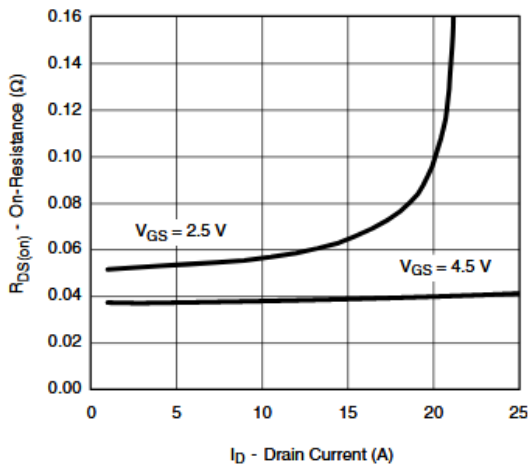
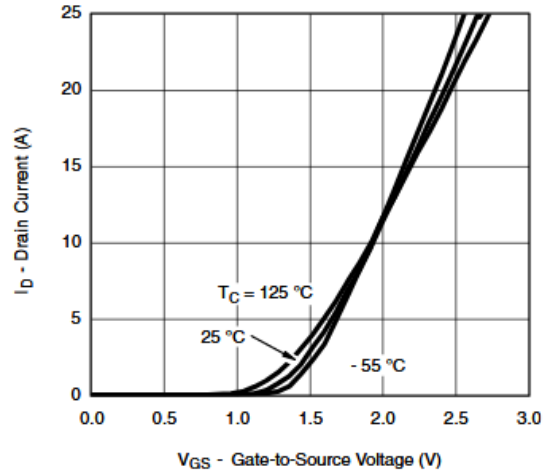
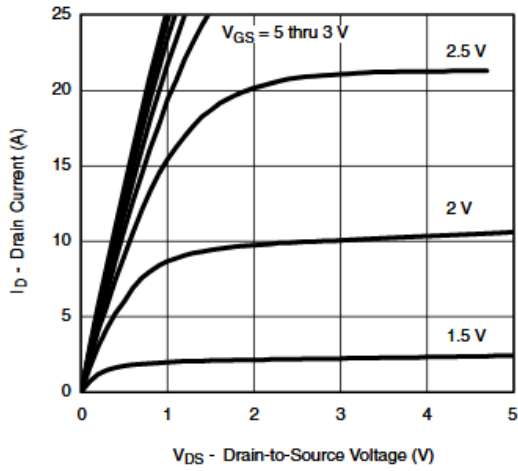



➤ **P-Channel Typical Characteristics**($T_A=25^\circ\text{C}$ unless otherwise noted)

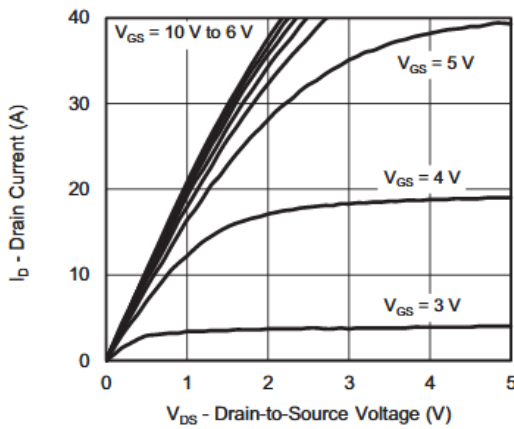

Output Characteristics

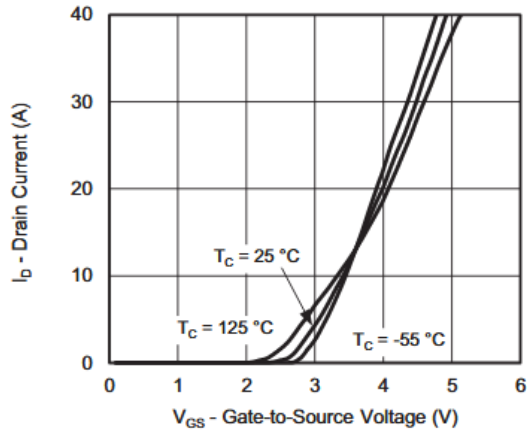

Transfer Characteristics

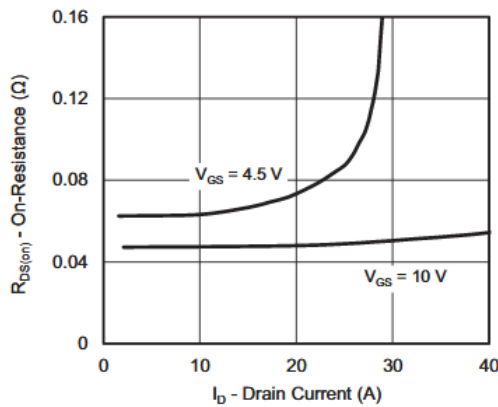

On-Resistance vs. Drain Current and Gate Voltage

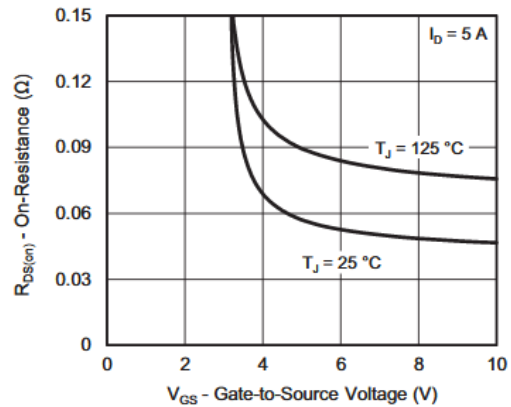

On-Resistance vs. Gate-to-Source Voltage

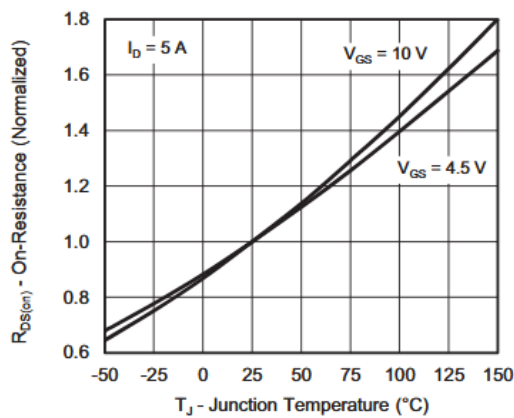

On-Resistance vs. Junction Temperature

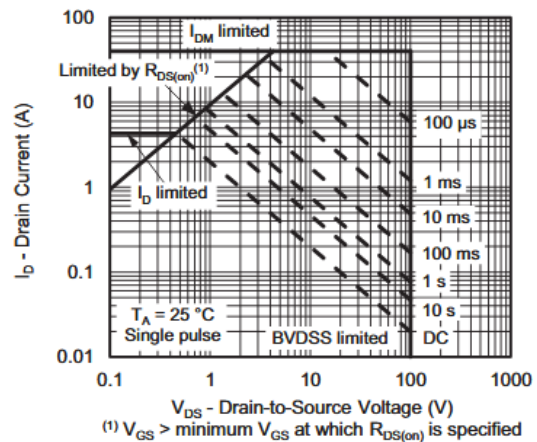

Safe Operating Area, Junction-to-Ambient

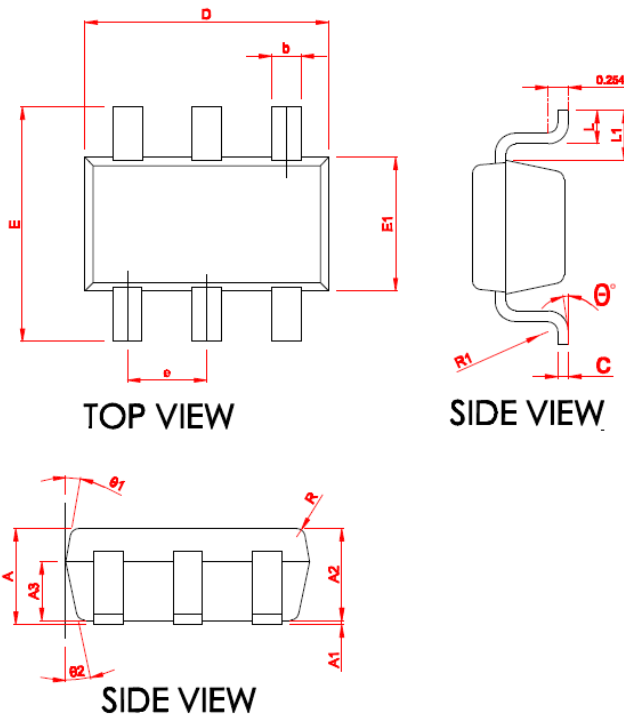
➤ Package Information

SYMBOL	MILLIMETER		
	MIN	NOM	MAX
A	1.06	1.15	1.24
* A1	0.01	0.05	0.09
* A2	1.05	1.10	1.15
A3	0.65	0.70	0.75
* b	0.30	0.35	0.45
* c	0.117	0.127	0.157
* D	2.87	2.92	2.97
* E	2.72	2.80	2.88
* E1	1.55	1.60	1.65
* e	0.90	0.95	1.00
* L	0.32	0.40	0.48
* L1	0.55	0.60	0.65
R	0.10 REF		
R1	0.12 REF		
* θ	0	--	8°
θ_1	8°	10°	12°
θ_2	10°	12°	14°

DISCLAIMER

SSCSEMI RESERVES THE RIGHT TO MAKE CHANGES WITHOUT FURTHER NOTICE TO ANY PRODUCTS HEREIN TO IMPROVE RELIABILITY, FUNCTION OR DESIGN. SSCSEMI DOES NOT ASSUME ANY LIABILITY ARISING OUT OF THE APPLICATION OR USE OF ANY PRODUCT OR CIRCUIT DESCRIBED HEREIN; NEITHER DOES IT CONVEY ANY LICIENCE UNDER ITS PATENT RIGHTS, NOR THE RIGHTS OF OTHERS.

THE GRAPHS PROVIDED IN THIS DOCUMENT ARE STATISTICAL SUMMARIES BASED ON A LIMITED NUMBER OF SAMPLES AND ARE PROVIDED FOR INFORMATIONAL PURPOSE ONLY. THE PERFORMANCE CHARACTERISTICS LISTED IN THEM ARE NOT TESTED OR GUARANTEED. IN SOME GRAPHS, THE DATA PRESENTED MAY BE OUTSIDE THE SPECIFIED OPERATING RANGE (E.G. OUTSIDE SPECIFIED POWER SUPPLY RANGE) AND THEREFORE OUTSIDE THE WARRANTED RANGE.

OUR PRODUCT SPECIFICATIONS ARE ONLY VALID IF OBTAINED THROUGH THE COMPANY'S OFFICIAL WEBSITE, CRM SYSTEM, OR OUR SALES PERSONNEL CHANNELS. IF CHANGES OR SPECIAL VERSIONS ARE INVOLVED, THEY MUST BE STAMPED WITH A QUALITY SEAL AND MARKED WITH A SPECIAL VERSION NUMBER TO BE VALID.