



SSCN143EGS6

NPN Type Digital Transistor (built-in resistors)

Features

VCC	VIN	IO	R1	R2/R1 Typ.
50V	-10~+30V	100mA	4.7kΩ	1.0

Description

Built-in bias resistors enable the configuration of an inverter circuit without connecting external input resistors (see equivalent circuit).

The bias resistors consist of thin-film resistors with complete isolation to allow negative biasing of the input. They also have the advantage of almost completely eliminating parasitic effects. Only the on/off conditions need to be set for operation, making the device design easy.

Applications

- Amplifying signal
- Electronic switch
- Oscillating circuit
- Variable resistance

Ordering Information

Device	Package	Shipping
SSCN143EGS6	SOT-23	3000/Reel

Pin configuration

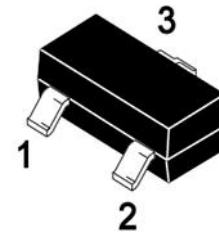

SOT-23

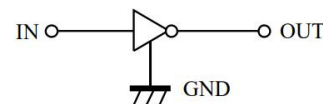
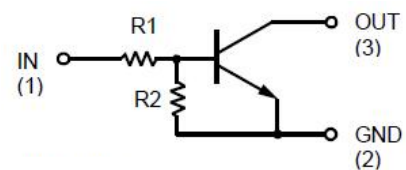

Circuit Diagram

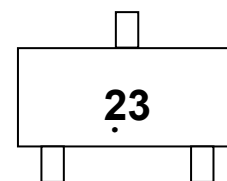

Marking (Top View)



➤ **Absolute Maximum Ratings**($T_A=25^{\circ}\text{C}$ unless otherwise noted)

Parameter	Symbol	Value	Unit
Supply Voltage	V_{CC}	50	V
Input Voltage	V_{IN}	-10 to +30	V
Output current	I_o	100	mA
Power Dissipation	P_D	200	mW
Junction Temperature	T_J	-55 to 150	$^{\circ}\text{C}$
Storage Temperature	T_{STG}	-55 to 150	$^{\circ}\text{C}$

➤ **Electrical Characteristics** ($T_A=25^{\circ}\text{C}$ unless otherwise noted)

Parameter	Symbol	Test Conditions	Min.	Typ.	Max.	Unit
Input Voltage	$V_{I(off)}$	$V_{CC} = 5V, I_o = 0.1mA$	0.5			V
	$V_{I(on)}$	$V_{CC} = 0.3V, I_o = 20mA$			3	V
Output Voltage	$V_{O(on)}$	$I_o/I_i = 10mA/0.5mA$			0.3	V
Input Current	I_i	$V_i = 5V$			1.8	mA
Output Current	$I_{O(off)}$	$V_{CC} = 50V, V_i = 0V$			0.5	μA
DC Current Gain	G_1	$V_o = 5V, I_o = 10mA$	20			
Input Resistance	R_1		3.29	4.7	6.11	$\text{K}\Omega$
Resistance Ration	R_2/R_1		0.8	1.0	1.2	
Transition Frequency	f_T	$V_o = 10V, I_o = 5mA, f = 100\text{MHz}$		250		MHz



➤ Typical Performance Characteristics ($T_A=25^\circ\text{C}$ unless otherwise noted)

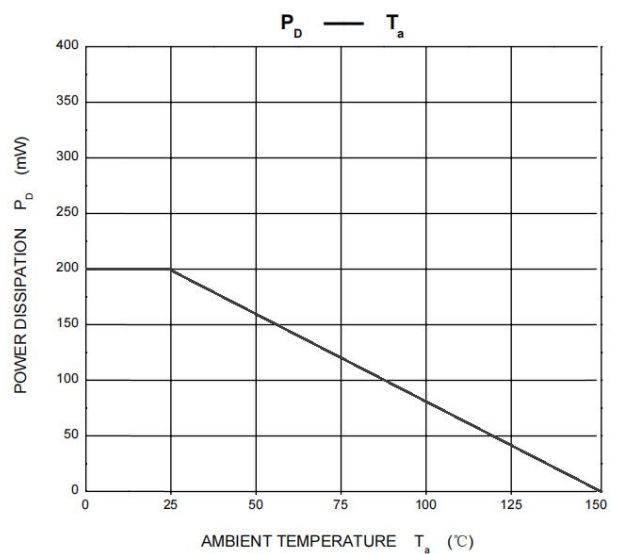
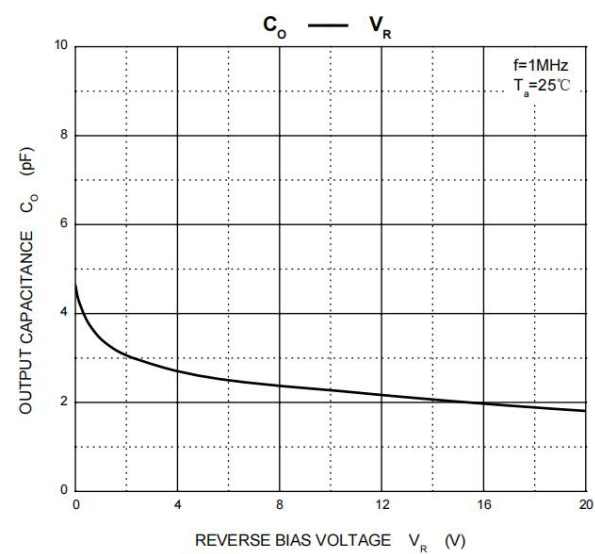
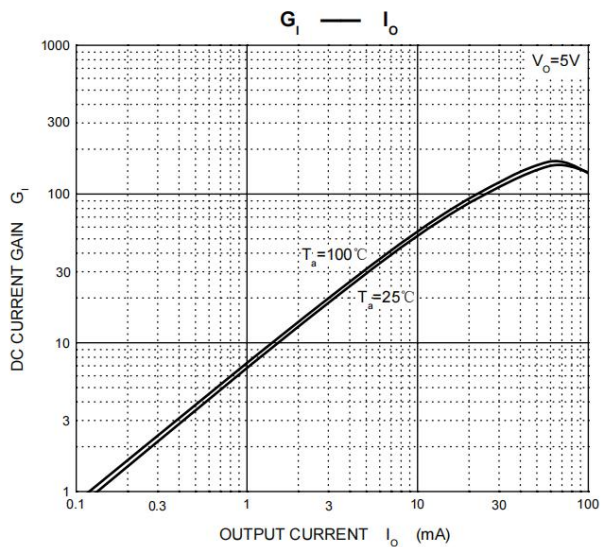
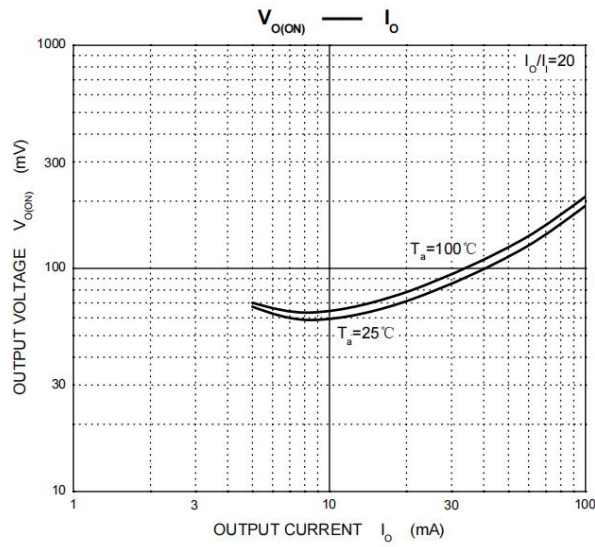
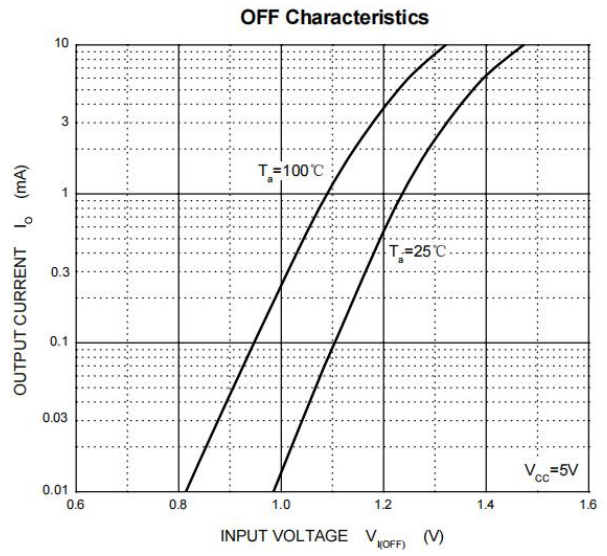
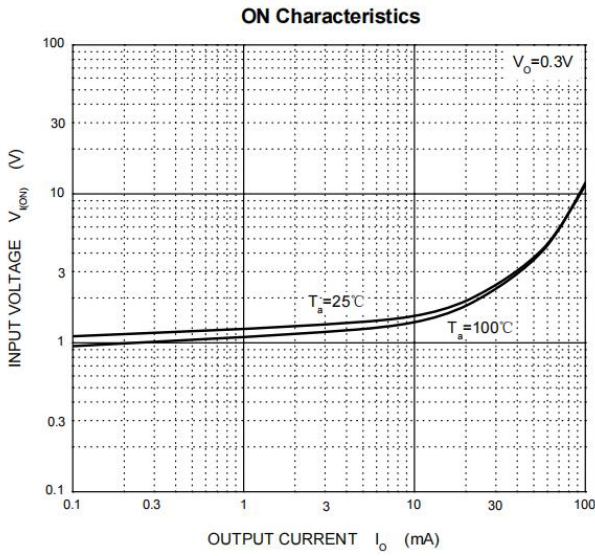

➤ Package Information

● Mechanical Data

SOT-23

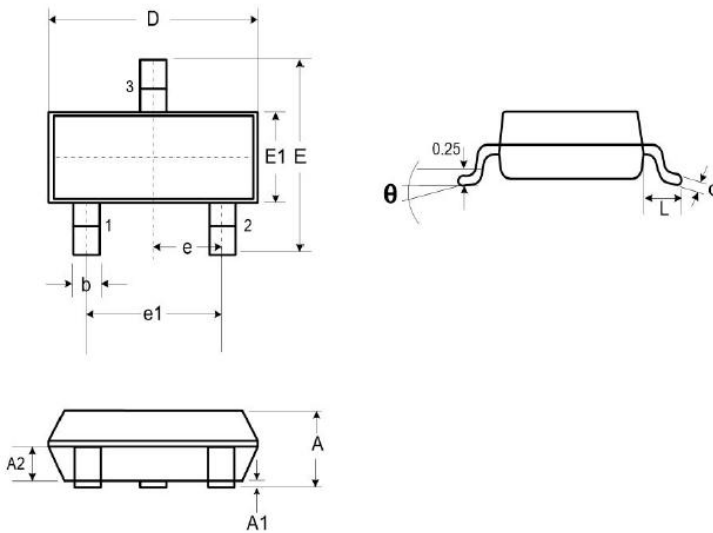

DIM	Millimeters		
	Min.	Typ.	Max.
A	0.89	-	1.12
A1	0.01	-	0.10
A2	0.88	0.95	1.02
b	0.30	-	0.51
c	0.08	-	0.18
D	2.80	2.90	3.04
E	2.10	2.37	2.64
E1	1.20	1.30	1.40
e	0.95		
e1	1.90		
L	0.40	0.50	0.60
L1	0.55		
N	3		
θ	0°	-	8°

● Recommended Pad outline

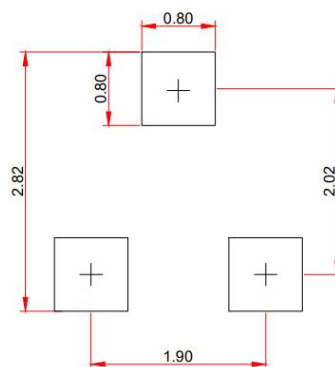



DISCLAIMER

SSCSEMI RESERVES THE RIGHT TO MAKE CHANGES WITHOUT FURTHER NOTICE TO ANY PRODUCTS HEREIN TO IMPROVE RELIABILITY, FUNCTION OR DESIGN. SSCSEMI DOES NOT ASSUME ANY LIABILITY ARISING OUT OF THE APPLICATION OR USE OF ANY PRODUCT OR CIRCUIT DESCRIBED HEREIN; NEITHER DOES IT CONVEY ANY LICIENCE UNDER ITS PATENT RIGHTS, NOR THE RIGHTS OF OTHERS.

THE GRAPHS PROVIDED IN THIS DOCUMENT ARE STATISTICAL SUMMARIES BASED ON A LIMITED NUMBER OF SAMPLES AND ARE PROVIDED FOR INFORMATIONAL PURPOSE ONLY. THE PERFORMANCE CHARACTERISTICS LISTED IN THEM ARE NOT TESTED OR GUARANTEED. IN SOME GRAPHS, THE DATA PRESENTED MAY BE OUTSIDE THE SPECIFIED OPERATING RANGE (E.G. OUTSIDE SPECIFIED POWER SUPPLY RANGE) AND THEREFORE OUTSIDE THE WARRANTED RANGE.

OUR PRODUCT SPECIFICATIONS ARE ONLY VALID IF OBTAINED THROUGH THE COMPANY'S OFFICIAL WEBSITE, CRM SYSTEM, OR OUR SALES PERSONNEL CHANNELS. IF CHANGES OR SPECIAL VERSIONS ARE INVOLVED, THEY MUST BE STAMPED WITH A QUALITY SEAL AND MARKED WITH A SPECIAL VERSION NUMBER TO BE VALID.