



## SSCN8050MGS6

### High Frequency High Gain NPN Power BJT

#### ➤ Features

VCB	VCE	VBE	VCESAT	IC
40V	25V	6V	500mV	800mA

#### ➤ Description

This device is produced with advanced high carrier density technology, which is especially used to minimize saturation voltage drop. This device particularly suits low voltage applications such as portable equipment, power management and other battery powered circuits, and low in-line power dissipation are needed in a very small outline surface mount package. Excellent thermal and electrical capabilities.

#### ➤ Applications

- Supply line switching circuits
- Battery management application
- DC/DC converter applications

#### ➤ Ordering Information

Device	Package	Shipping
SSCN8050MGS6	SOT-23	3000/Reel

#### ➤ Pin configuration

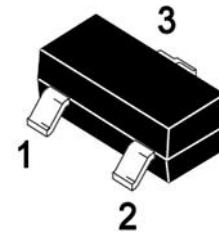

**SOT-23**

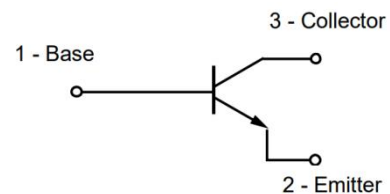

**Circuit Diagram**

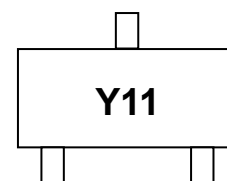

**Marking(Top View)**



➤ **Absolute Maximum Ratings**( $T_A=25^{\circ}\text{C}$  unless otherwise noted)

Parameter	Symbol	Value	Unit
Collector-Base Voltage	$V_{CB0}$	40	V
Collector- Emitter Voltage	$V_{CE0}$	25	V
Emitter-Base Voltage	$V_{EB0}$	6	V
Collector Current-Continuous	$I_C$	800	mA
Collector Power Dissipation	$P_C$	200	mW
Junction Temperature	$T_J$	150	$^{\circ}\text{C}$
Storage Temperature	$T_{STG}$	-55 to 150	$^{\circ}\text{C}$

➤ **Electrical Characteristics** ( $T_A=25^{\circ}\text{C}$  unless otherwise noted)

Parameter	Symbol	Test Conditions	Min.	Typ.	Max.	Unit
Collector-Base Breakdown Voltage	$BV_{CB0}$	$I_C=0.1\text{mA}, I_E=0$	40			V
Collector-emitter Breakdown Voltage	$BV_{CE0}$	$I_C=1\text{mA}, I_B=0$	25			V
Emitter -Base Breakdown Voltage	$BV_{EB0}$	$I_E=0.1\text{mA}, I_C=0$	6			V
Collector Cutoff Current	$I_{CB0}$	$V_{CB}=35\text{V}, I_E=0$			0.1	$\mu\text{A}$
Collector Cutoff Current	$I_{CE0}$	$V_{CE}=20\text{V}, I_B=0$			0.1	$\mu\text{A}$
DC Current Gain	$h_{FE1}$	$V_{CE}=1\text{V}, I_C=5\text{mA}$	45			
	$h_{FE2}$	$V_{CE}=1\text{V}, I_C=100\text{mA}$	80		400	
	$h_{FE3}$	$V_{CE}=1\text{V}, I_C=800\text{mA}$	40			
Collector-Emitter Saturation Voltage	$V_{CE(sat)}$	$I_C=500\text{mA}, I_B=80\text{mA}$			0.5	V
Base-Emitter Saturation Voltage	$V_{BE(sat)}$	$I_C=500\text{mA}, I_B=80\text{mA}$			1.2	V
Transition frequency	$f_T$	$V_{CE}=6\text{V}, I_C=20\text{mA}$ $f=30\text{MHz}$	150			MHz



## ➤ Typical Performance Characteristics ( $T_A=25^\circ\text{C}$ unless otherwise noted)

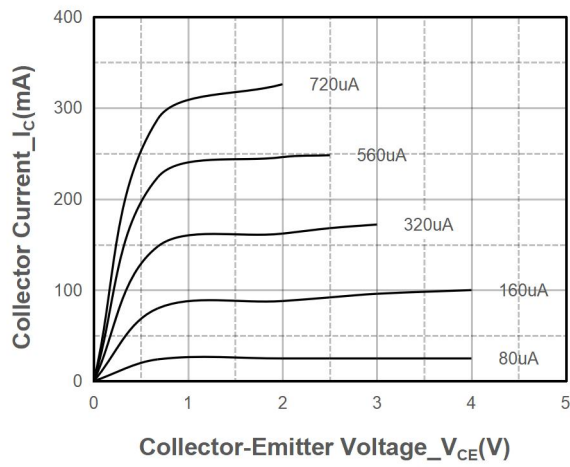

Collector Current vs. Collector-Emitter Voltage

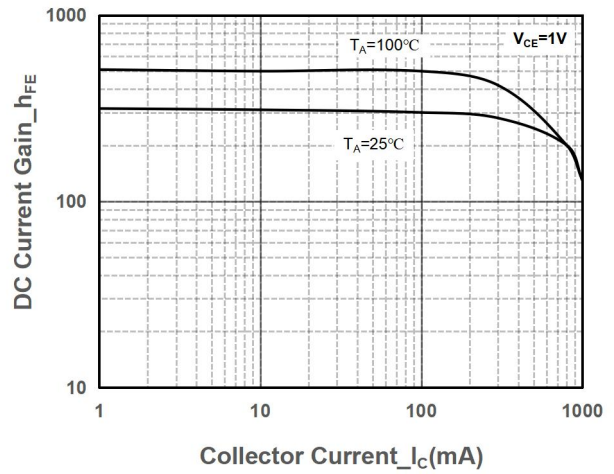

DC Current Gain vs. Collector Current

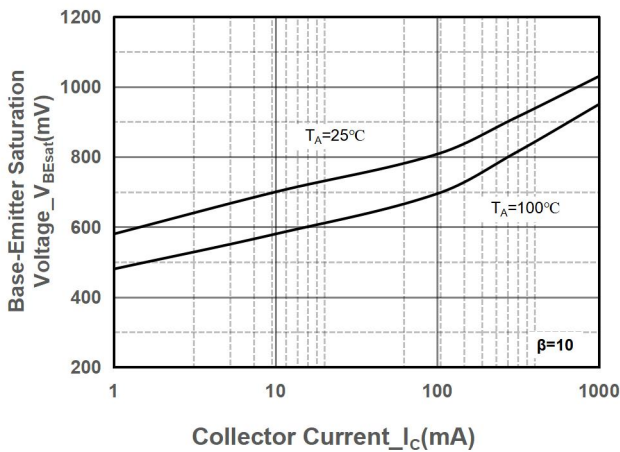

$V_{BE(sat)}$  vs. Collector Current

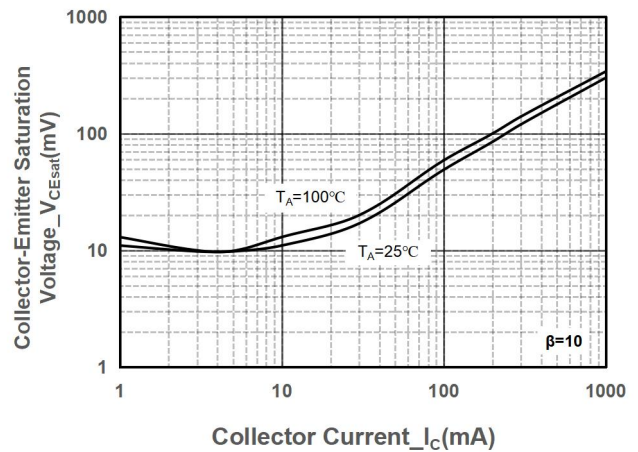

$V_{CE(sat)}$  vs. Collector Current

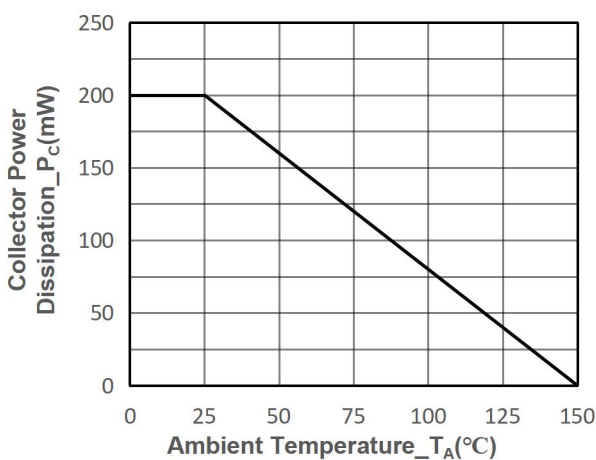

Power derating vs. Ambient temperature

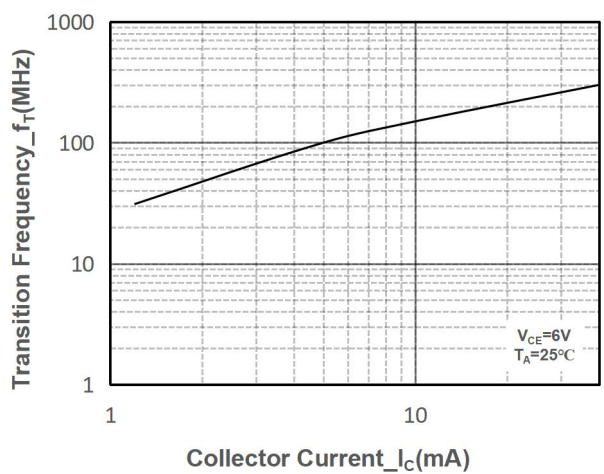

Transition Frequency vs. Collector Current



## ➤ Package Information

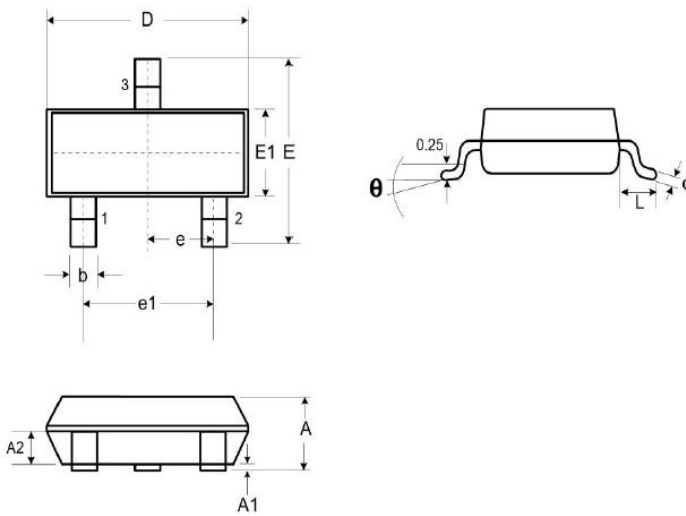

DIM	Millimeters		
	Min.	Typ.	Max.
A	0.89	-	1.12
A1	0.01	-	0.10
A2	0.88	0.95	1.02
b	0.30	-	0.51
c	0.08	-	0.18
D	2.80	2.90	3.04
E	2.10	2.37	2.64
E1	1.20	1.30	1.40
e1	1.90		
e	0.95		
L	0.40	0.50	0.60
L1	0.55		
N	3		
θ	0°	-	8°

### Recommended Pad outline(Unit: mm)

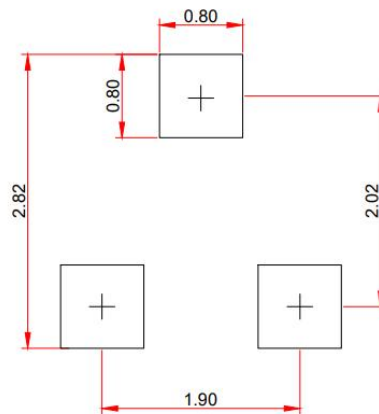



## DISCLAIMER

SSCSEMI RESERVES THE RIGHT TO MAKE CHANGES WITHOUT FURTHER NOTICE TO ANY PRODUCTS HEREIN TO IMPROVE RELIABILITY, FUNCTION OR DESIGN. SSCSEMI DOES NOT ASSUME ANY LIABILITY ARISING OUT OF THE APPLICATION OR USE OF ANY PRODUCT OR CIRCUIT DESCRIBED HEREIN; NEITHER DOES IT CONVEY ANY LICIENCE UNDER ITS PATENT RIGHTS, NOR THE RIGHTS OF OTHERS.

THE GRAPHS PROVIDED IN THIS DOCUMENT ARE STATISTICAL SUMMARIES BASED ON A LIMITED NUMBER OF SAMPLES AND ARE PROVIDED FOR INFORMATIONAL PURPOSE ONLY. THE PERFORMANCE CHARACTERISTICS LISTED IN THEM ARE NOT TESTED OR GUARANTEED. IN SOME GRAPHS, THE DATA PRESENTED MAY BE OUTSIDE THE SPECIFIED OPERATING RANGE (E.G. OUTSIDE SPECIFIED POWER SUPPLY RANGE) AND THEREFORE OUTSIDE THE WARRANTED RANGE.

OUR PRODUCT SPECIFICATIONS ARE ONLY VALID IF OBTAINED THROUGH THE COMPANY'S OFFICIAL WEBSITE, CRM SYSTEM, OR OUR SALES PERSONNEL CHANNELS. IF CHANGES OR SPECIAL VERSIONS ARE INVOLVED, THEY MUST BE STAMPED WITH A QUALITY SEAL AND MARKED WITH A SPECIAL VERSION NUMBER TO BE VALID.