



SSCNA42GS6

High Frequency High Gain NPN Power BJT

➤ Features

VCB	VCE	VEB	IC
300V	300V	5V	300mA

➤ Description

This device is designed for general-purpose high-voltage amplifiers and gas discharge display drivers. It is Ideal for medium power amplification and switching.

➤ Applications

- Amplifying signal
- Electronic switch
- Oscillating circuit
- Variable resistance

➤ Ordering Information

Device	Package	Shipping
SSCNA42GS6	SOT-23	3000/Reel

➤ Pin configuration



SOT-23

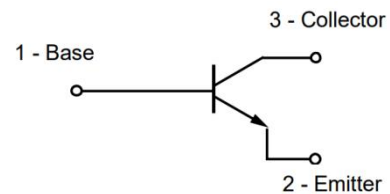

Circuit Diagram

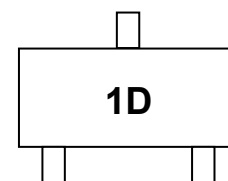

Marking (Top View)



➤ **Absolute Maximum Ratings**($T_A=25^{\circ}\text{C}$ unless otherwise noted)

Parameter	Symbol	Value	Unit
Collector-Base Voltage	V_{CB0}	300	V
Collector- Emitter Voltage	V_{CE0}	300	V
Emitter-Base Voltage	V_{EB0}	5	V
Collector Current-Continuous	I_C	300	mA
Collector Current-Peak	I_{CM}	500	mA
Collector Power Dissipation	P_C	350	mW
Thermal Resistance, Junction to Ambient	$R_{\theta JA}$	357	$^{\circ}\text{C}/\text{W}$
Junction Temperature	T_J	-55 to 150	$^{\circ}\text{C}$
Storage Temperature	T_{STG}	-55 to 150	$^{\circ}\text{C}$

➤ **Electrical Characteristics** ($T_A=25^{\circ}\text{C}$ unless otherwise noted)

Parameter	Symbol	Test Conditions	Min.	Typ.	Max.	Unit
Collector-Base Breakdown Voltage	BV_{CB0}	$I_C=0.1\text{mA}, I_E=0$	300			V
Collector-emitter Breakdown Voltage	BV_{CE0}	$I_C=1\text{mA}, I_B=0$	300			V
Emitter -Base Breakdown Voltage	BV_{EB0}	$I_E=0.1\text{mA}, I_C=0$	5			V
Collector Cutoff Current	I_{CB0}	$V_{CB}=200\text{V}, I_E=0$			0.25	μA
Emitter Cutoff Current	I_{EB0}	$V_{EB}=5\text{V}, I_C=0$			0.1	μA
DC Current Gain	h_{FE}	$V_{CE}=10\text{V}, I_C=1\text{mA}$	60			
		$V_{CE}=10\text{V}, I_C=10\text{mA}$	100	200		
		$V_{CE}=10\text{V}, I_C=30\text{mA}$	60			
Collector-Emitter Saturation Voltage	$V_{CE(sat)}$	$I_C=20\text{mA}, I_B=2\text{mA}$			0.2	V
Base-Emitter Saturation Voltage	$V_{BE(sat)}$	$I_C=20\text{mA}, I_B=2\text{mA}$			0.9	V
Transition frequency	f_T	$V_{CE}=20\text{V}, I_C=10\text{mA}$ $f=30\text{MHz}$	50			MHz



➤ Typical Performance Characteristics ($T_A=25^\circ\text{C}$ unless otherwise noted)

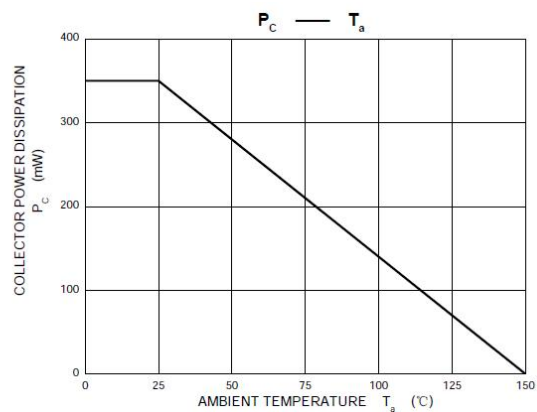
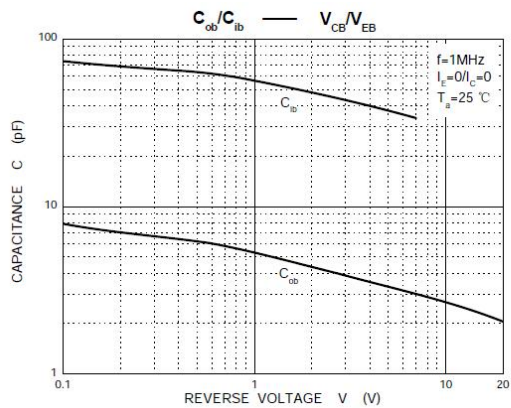
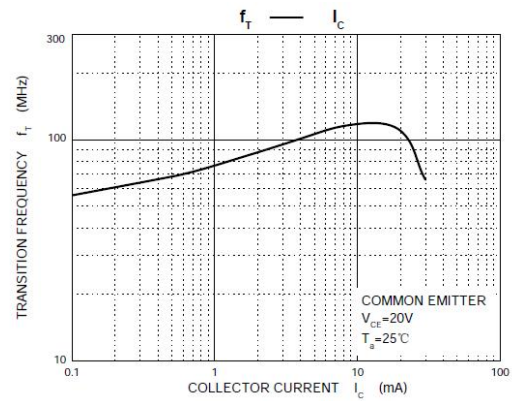
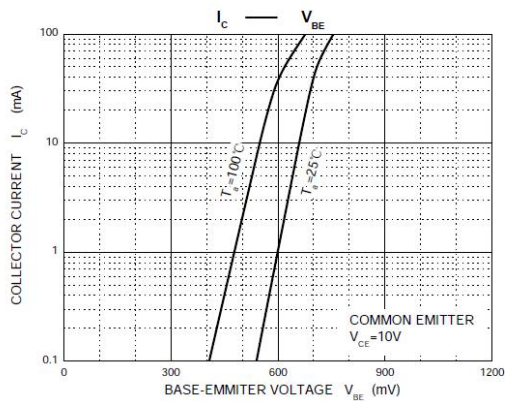
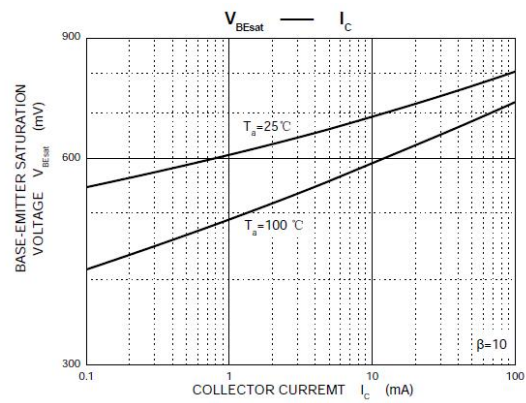
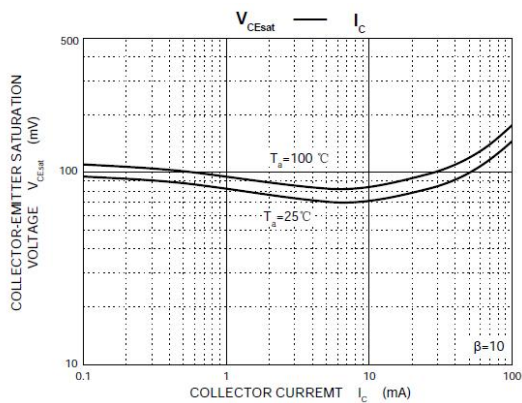
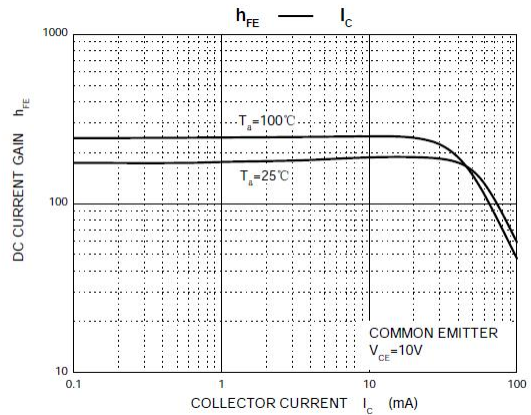
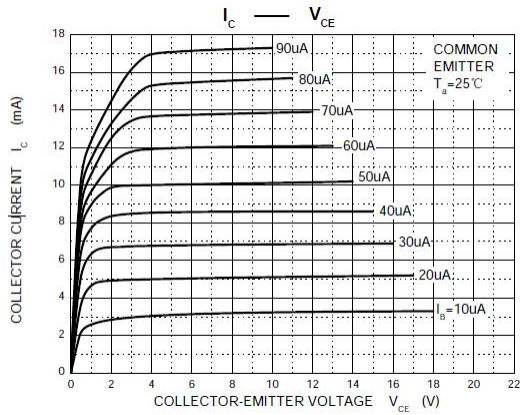



➤ **Package Information**

● **Mechanical Data**

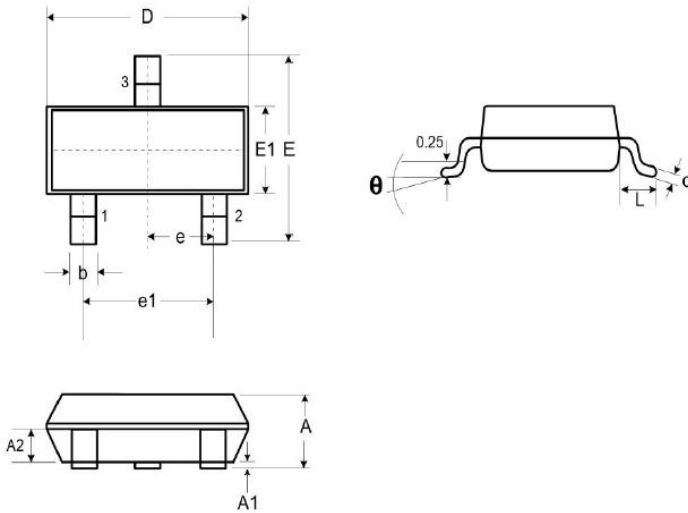

DIM	Millimeters		
	Min.	Typ.	Max.
A	0.89	-	1.12
A1	0.01	-	0.10
A2	0.88	0.95	1.02
b	0.30	-	0.51
c	0.08	-	0.18
D	2.80	2.90	3.04
E	2.10	2.37	2.64
E1	1.20	1.30	1.40
e1	1.90		
e	0.95		
L	0.40	0.50	0.60
L1	0.55		
N	3		
θ	0°	-	8°

● **Recommended Pad outline (Unit: mm)**

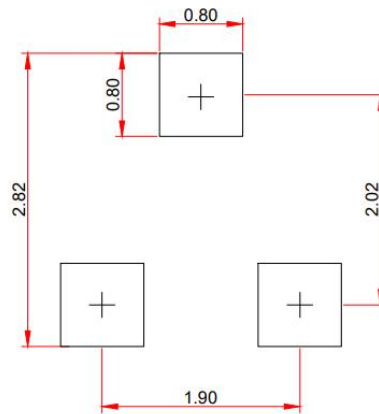



DISCLAIMER

SSCSEMI RESERVES THE RIGHT TO MAKE CHANGES WITHOUT FURTHER NOTICE TO ANY PRODUCTS HEREIN TO IMPROVE RELIABILITY, FUNCTION OR DESIGN. SSCSEMI DOES NOT ASSUME ANY LIABILITY ARISING OUT OF THE APPLICATION OR USE OF ANY PRODUCT OR CIRCUIT DESCRIBED HEREIN; NEITHER DOES IT CONVEY ANY LICIENCE UNDER ITS PATENT RIGHTS, NOR THE RIGHTS OF OTHERS.

THE GRAPHS PROVIDED IN THIS DOCUMENT ARE STATISTICAL SUMMARIES BASED ON A LIMITED NUMBER OF SAMPLES AND ARE PROVIDED FOR INFORMATIONAL PURPOSE ONLY. THE PERFORMANCE CHARACTERISTICS LISTED IN THEM ARE NOT TESTED OR GUARANTEED. IN SOME GRAPHS, THE DATA PRESENTED MAY BE OUTSIDE THE SPECIFIED OPERATING RANGE (E.G. OUTSIDE SPECIFIED POWER SUPPLY RANGE) AND THEREFORE OUTSIDE THE WARRANTED RANGE.

OUR PRODUCT SPECIFICATIONS ARE ONLY VALID IF OBTAINED THROUGH THE COMPANY'S OFFICIAL WEBSITE, CRM SYSTEM, OR OUR SALES PERSONNEL CHANNELS. IF CHANGES OR SPECIAL VERSIONS ARE INVOLVED, THEY MUST BE STAMPED WITH A QUALITY SEAL AND MARKED WITH A SPECIAL VERSION NUMBER TO BE VALID.