



SSCP3906GS9

PNP Switching Transistor

➤ Features

VCB	VCE	VBE	IC
-40V	-40V	-5V	-200mA

➤ Description

The PNP Transistor is designed for use in linear and switching applications. The device is housed in the SOT-723 package, which is designed for telephony and professional communication equipment.

➤ Applications

- General purpose switching and amplification
- Telephony and professional communication equipment

➤ Ordering Information

Device	Package	Shipping
SSCP3906GS9	SOT-723	8000/Reel

➤ Pin configuration

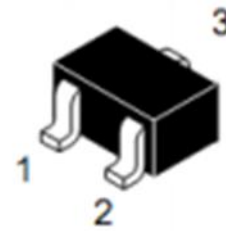

SOT-723

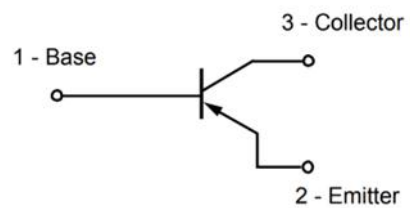

Circuit Diagram

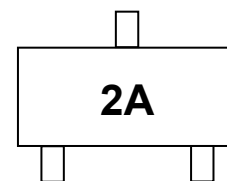

Marking (Top View)



➤ **Absolute Maximum Ratings**($T_A=25^{\circ}\text{C}$ unless otherwise noted)

Parameter	Symbol	Value	Unit
Collector-Base Voltage	V_{CB0}	-40	V
Collector- Emitter Voltage	V_{CEO}	-40	V
Emitter-Base Voltage	V_{EBO}	-5	V
Collector Current-Continuous	I_C	-200	mA
Collector Power Dissipation	P_C	200	mW
Junction Temperature	T_J	150	$^{\circ}\text{C}$
Storage Temperature	T_{STG}	-55 to 150	$^{\circ}\text{C}$

➤ **Electrical Characteristics** ($T_A=25^{\circ}\text{C}$ unless otherwise noted)

Parameter	Symbol	Test Conditions	Min.	Typ.	Max.	Unit
Collector-Base Breakdown Voltage	BV_{CB0}	$I_C=-10\mu\text{A}, I_E=0$	-40			V
Collector-emitter Breakdown Voltage	BV_{CEO}	$I_C=-1\text{mA}, I_B=0$	-40			V
Emitter -Base Breakdown Voltage	BV_{EBO}	$I_E=-10\mu\text{A}, I_C=0$	-5			V
Collector Cutoff Current	I_{CEX}	$V_{CE}=-30\text{V}, V_{EB}=-3\text{V}$			-50	nA
Collector Cutoff Current	I_{CBO}	$V_{CB}=-30\text{V}, I_E=0$			-100	nA
Emitter Cutoff Current	I_{EBO}	$V_{EB}=-3\text{V}, I_C=0$			-100	nA
DC Current Gain	h_{FE}	$V_{CE}=-1\text{V}, I_C=-10\text{mA}$	100		300	
		$V_{CE}=-1\text{V}, I_C=-0.1\text{mA}$	60			
		$V_{CE}=-1\text{V}, I_C=-100\text{mA}$	30			
Collector-Emitter Saturation Voltage	$V_{CE(sat)}$	$I_C=-50\text{mA}, I_B=-5\text{mA}$			-0.4	V
Base-Emitter Saturation Voltage	$V_{BE(sat)}$	$I_C=-50\text{mA}, I_B=-5\text{mA}$			-0.95	V
Transition frequency	f_T	$V_{CE}=-20\text{V}, I_C=-10\text{mA}$ $f=100\text{MHz}$	250			MHz
Delay Time	t_d	$V_{CC}=-3\text{V}, V_{BE}=0.5\text{V}$			35	ns
Rise Time	t_r	$I_C=-10\text{mA}, I_{B1}=-1\text{mA}$			35	ns
Storage Time	t_s	$V_{CC}=-3\text{V}, I_C=-10\text{mA}$			225	ns
Fall Time	t_f	$I_{B1}=-I_{B2}=-1\text{mA}$			75	ns



➤ Typical Performance Characteristics ($T_A=25^\circ\text{C}$ unless otherwise noted)

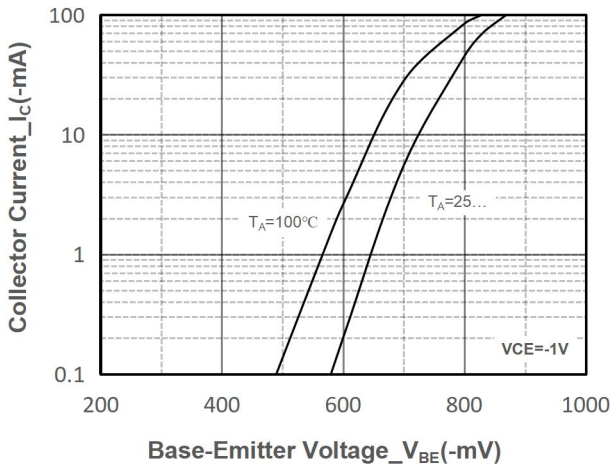

Collector Current vs. Base-Emitter Voltage

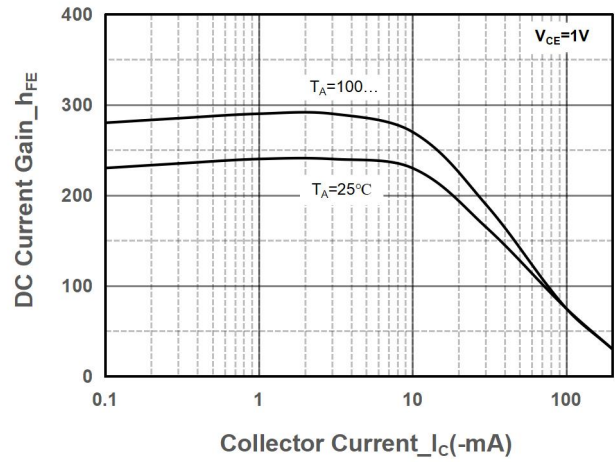

DC Current Gain vs. Collector Current

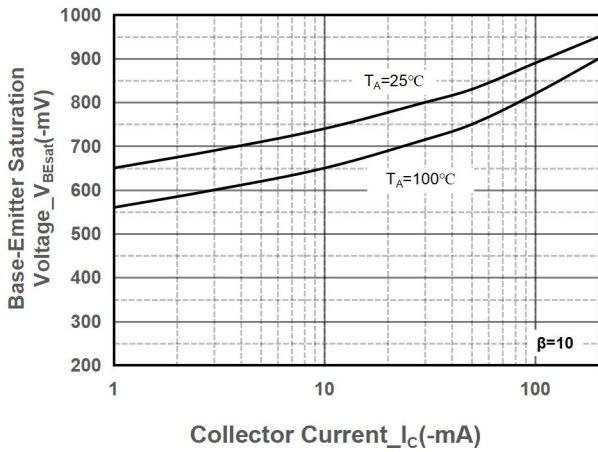

$V_{BE(sat)}$ vs. Collector Current

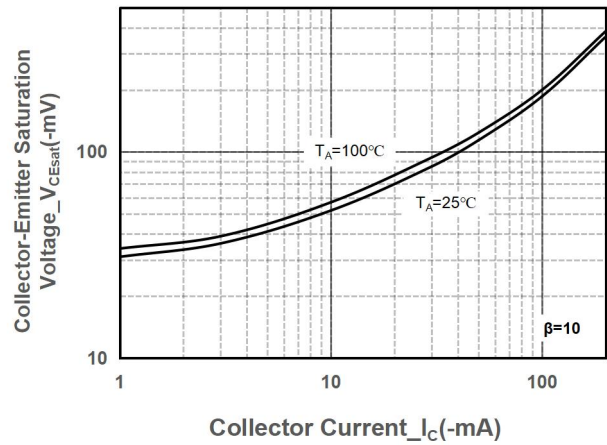

$V_{CE(sat)}$ vs. Collector Current

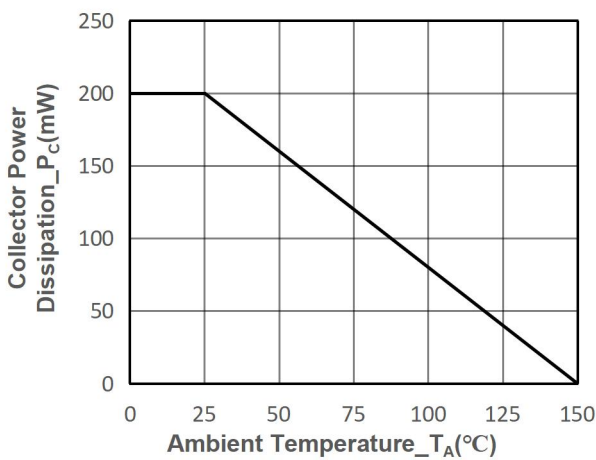

Power derating vs. Ambient temperature

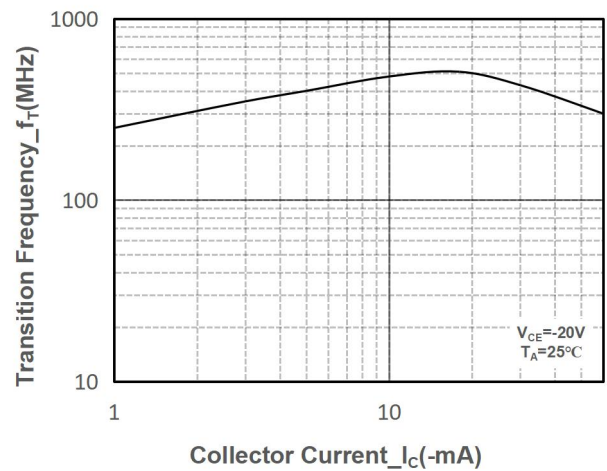

Transition Frequency vs. Collector Current



➤ Package Information

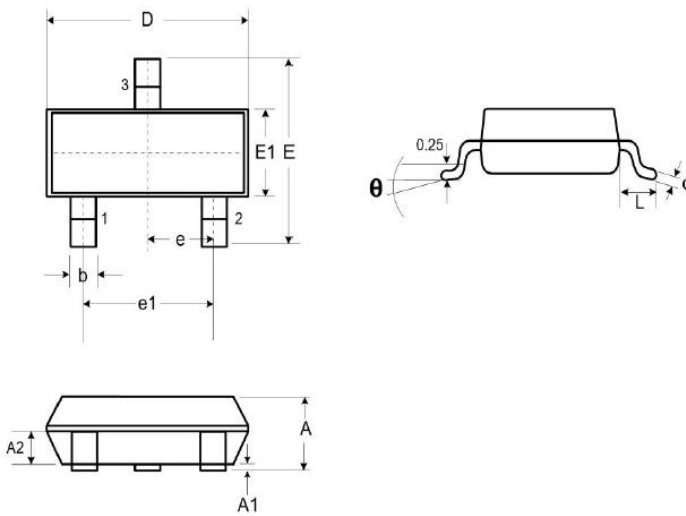

DIM	Millimeters		
	Min.	Typ.	Max.
A	0.89	-	1.12
A1	0.01	-	0.10
A2	0.88	0.95	1.02
b	0.30	-	0.51
c	0.08	-	0.18
D	2.80	2.90	3.04
E	2.10	2.37	2.64
E1	1.20	1.30	1.40
e	0.95		
e1	1.90		
L	0.40	0.50	0.60
L1	0.55		
N	3		
θ	0°	-	8°

Recommended Pad outline (Unit: mm)

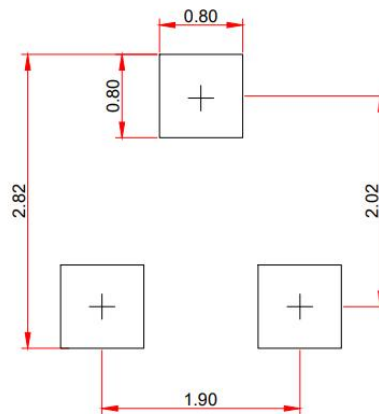



DISCLAIMER

SSCSEMI RESERVES THE RIGHT TO MAKE CHANGES WITHOUT FURTHER NOTICE TO ANY PRODUCTS HEREIN TO IMPROVE RELIABILITY, FUNCTION OR DESIGN. SSCSEMI DOES NOT ASSUME ANY LIABILITY ARISING OUT OF THE APPLICATION OR USE OF ANY PRODUCT OR CIRCUIT DESCRIBED HEREIN; NEITHER DOES IT CONVEY ANY LICIENCE UNDER ITS PATENT RIGHTS, NOR THE RIGHTS OF OTHERS.

THE GRAPHS PROVIDED IN THIS DOCUMENT ARE STATISTICAL SUMMARIES BASED ON A LIMITED NUMBER OF SAMPLES AND ARE PROVIDED FOR INFORMATIONAL PURPOSE ONLY. THE PERFORMANCE CHARACTERISTICS LISTED IN THEM ARE NOT TESTED OR GUARANTEED. IN SOME GRAPHS, THE DATA PRESENTED MAY BE OUTSIDE THE SPECIFIED OPERATING RANGE (E.G. OUTSIDE SPECIFIED POWER SUPPLY RANGE) AND THEREFORE OUTSIDE THE WARRANTED RANGE.

OUR PRODUCT SPECIFICATIONS ARE ONLY VALID IF OBTAINED THROUGH THE COMPANY'S OFFICIAL WEBSITE, CRM SYSTEM, OR OUR SALES PERSONNEL CHANNELS. IF CHANGES OR SPECIAL VERSIONS ARE INVOLVED, THEY MUST BE STAMPED WITH A QUALITY SEAL AND MARKED WITH A SPECIAL VERSION NUMBER TO BE VALID.